

# SIGNS

## Town Planning Scheme Policy No. 32

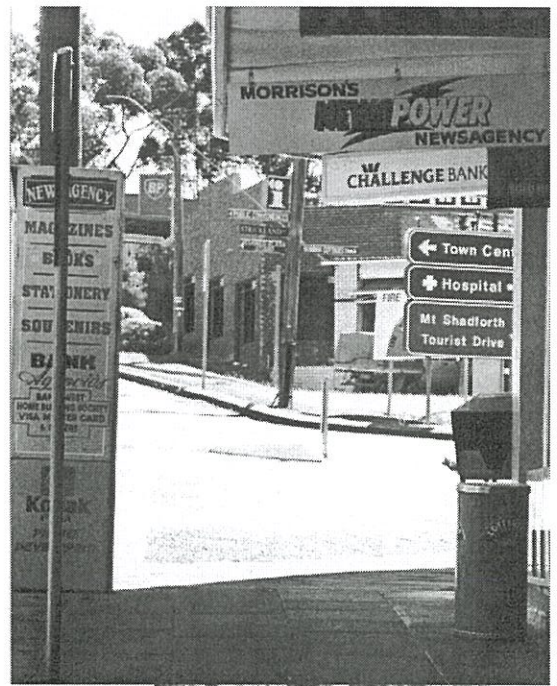
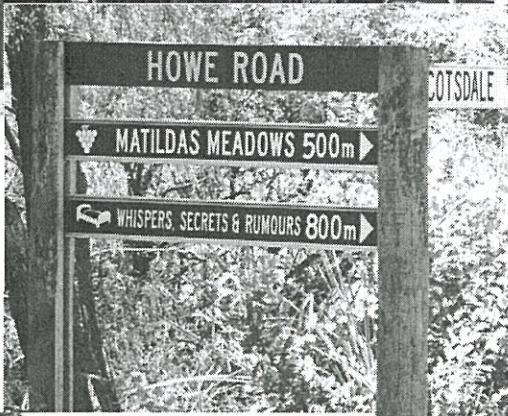

Adopted on 22<sup>nd</sup> May, 2001 in accordance with Clause 8.2 of Town Planning Scheme No. 3

## CONTENTS

Aims	2
Objectives	2
Application	2
1.0 Introduction	3
2.0 Signs – Zoning Chart	5
3.0 Standards for all Signs	6
4.0 Total Site Signage Plan	7
5.0 Business Direction Signs	9
6.0 Rural Business Signs on the Actual Property	11
7.0 Real Estate Directional Signs	12
8.0 Real Estate Development Signs	13
9.0 Real Estate “For Sale” Signs	14
10.0 On Building Signs	14
10.1 Above Roof Signs	14
10.2 Part of Roof Signs	15
10.3 Wall Signs	15
10.4 Projecting Signs	17
10.5 Window Signs	20
11.0 Off Buildings Signs	20
11.1 Pylon Signs	20
11.2 On Ground Signs	21
11.3 Panel Signs	22
11.4 Hoarding Signs	22
11.5 Tethered Signs	23
11.6 Product Display Signs	23
11.7 Construction Site Signs	24
11.8 Display Home Signs	24
11.9 Signs for Public Information	25
12.0 Existing Signs	25
13.0 Prohibited Signs	25
14.0 Enforcement	26
15.0 Planning Consent	27
16.0 Fees	27
Additional Information Sheet for Advertisements Approval	28
Extract from T.P.S. No. 3 – Clause 5.30 Control of Advertisements	29
Extract from T.P.S. No. 3 – Appendix 10(a)	32
Extract from T.P.S. No. 3 – Appendix 10(b)	34

## **AIMS**

- 1. To guide the design, materials and siting of advertising structures and signs in the shire area that build upon the distinctive character of Denmark.*
- 2. To provide a clear direction in respect to all sign types.*

## **OBJECTIVES**

- 1. To preserve the heritage and landscape values and qualities of Denmark with a diverse economy ranging from rural production, retailing to tourism.*
- 2. To provide relevant information at appropriate locations to guide visitors to businesses and properties.*
- 3. To coordinate the style of signage through the use of components and features to achieve a strong distinct identity.*
- 4. To establish a standard of type-approved signs to clearly identify businesses.*
- 5. To set down requirements for direction signs and commercial signs.*
- 6. To reduce visual clutter, driver confusion, landscape detracting and traffic hazards caused by poor and indiscriminate signage.*
- 7. To ensure consistent policy and documentation throughout the shire.*
- 8. To clearly and simply set out the requirements of the Shire of Denmark for applicants making an application for outdoor advertising.*
- 9. To decrease the time and potential waste of resources involved in negotiations between applicants and Council.*
- 10. To decrease bureaucratic procedures, restrictions and constraints, as well as legal and jargonistic guidelines.*

## **APPLICATION**

*All of the Shire of Denmark including the townsite of Denmark, the rural districts and the nodal rural settlements of Nornalup, Peaceful Bay, Bow Bridge and Kenton.*

## 1.0 INTRODUCTION

- 1.1 This policy has been prepared to support and be read in conjunction with Clause 5.30 of Town Planning Scheme No. 3 (Control of Advertisements). Town Planning Scheme No. 3 requires the submission of an application for planning consent for non exempted advertisements which are listed in the Scheme. A copy of Clause 5.30 is attached to this Policy.
- 1.2 This Policy is about advertising signage within the Shire of Denmark - what signage is acceptable under the provisions of the Council's Town Planning Scheme, and how applications can be made for new signage, or for alterations to existing signage.
- 1.3 Advertising signage is about communicating messages to consumers, and it comes in many forms. It can be printed, painted, projected or illuminated onto a wide variety of surfaces. Illuminated signs can include neon tubes, floodlights or back lights. Flags, bunting, awnings, tethered balloons, pylon signs, window signs, roof signs, hoardings, fibre optics, television, flashing and chasing signs and animated signs are all examples of the broad scope of advertising.
- 1.4 Signs may be on buildings, facias, windows, walls or roofs. Freestanding signs may be on frames or on poles or on street furniture.
- 1.5 This policy is aimed at simplifying and explaining to potential advertisers or their agents the requirements of Council. It is not intended to be a strict rule to stifle high standard innovative design but rather is aimed at encouraging good quality signage that is appropriate for Denmark and its attractive setting.
- 1.6 A sign application must include sufficient information to enable assessment of the proposed sign(s).
- 1.7 Council's main concerns in regard to advertising signage relate to:
  - 1.7.1 visual impact on surrounding land and buildings;
  - 1.7.2 visual impact on streetscape; and
  - 1.7.3 visual impact on the overall locality.
- 1.8 When considering proposals for new advertising signage Council will have regard to:
  - 1.8.1 whether a new sign is compatible with any existing signs on the site;
  - 1.8.2 whether a new sign complements or detracts from the dominant character of the surrounding landscape;



- 1.8.3 whether a new sign complements or detracts from the architectural style and character of the building, site or area;
  - 1.8.4 whether a new sign compromises surrounding land uses due to its size, design, location or the use of illumination or devices such as flashing or moving elements;
  - 1.8.5 whether a new sign may be hazardous to vehicular or pedestrian traffic;
  - 1.8.6 whether a new sign on or attached to a heritage building is discreet and complements the building and area, and
  - 1.8.7 whether rationalisation or reduction in the number of existing signs is appropriate and achievable.
- 1.9 Where a proposed advertising sign or device is to be located within a reserve set aside under Town Planning Scheme No.3 Council will determine applications on their merits based on the principles embodied in this policy. As a guide, general advertising of this nature is not supported.

## 2.0 SIGNS – ZONING CHART

2.1 The Zoning Chart below has been developed to provide a simple check to assist persons in applying for signage approval. It shows the types of signs that are allowed in the different zones. For more detailed explanation of the sign types, the Policy sections relative to the specific sign type need to be read.

### 2.2 Signs – Zoning Chart

SIGN TYPE	ZONES									
	Commercial	Professional Office	Industrial	Residential	Special Residential	Special Rural	Landscape Protection	Rural Multiple Occupancy	Tourist	Rural
<b>ON BUILDING</b>										
Above Roof (10.1)	X	X	X	X	X	X	X	X	X	X
Part of Roof (10.2)	S	X	S	X	X	X	X	X	S	X
Wall (10.3)	P	S	P	S	X	X	X	X	P	S
Projecting (10.4)	P	S	P	X	X	X	X	X	P	S
Window (10.5)	PE	P	P	X	X	X	X	X	P	X
<b>OFF BUILDING</b>										
Rural Business (6.0)	X	X	X	X	X	X	X	X	X	P
Pylon (11.1)	S	X	S	X	X	X	X	X	X	X
On Ground (11.2)	P	S	P	X	X	X	X	X	P	X
Panel (11.3)	S	X	S	X	X	X	X	X	X	X
Hoarding (11.4)	X	X	X	X	X	X	X	X	X	X
Tethered (11.5)	X	X	X	X	X	X	X	X	X	X
Product Display (11.6)	X	X	P	X	X	X	X	X	X	P
<b>TEMPORARY</b>										
Real Estate Directional (7.0)	PE	PE	PE	PE	PE	PE	PE	PE	PE	PE
Real Estate Development (8.0)	P	X	P	P	P	P	P	X	P	X
Real Estate “For Sale” (9.0)	PE	PE	PE	PE	PE	PE	PE	PE	PE	PE
Construction Site (11.7)	PE	PE	PE	PE	PE	PE	PE	PE	PE	PE
Display Home (11.8)	X	X	X	PE	PE	X	X	X	X	X
Public Information (11.9)	P	P	P	P	P	P	P	P	P	P
<b>OTHER</b>										
Business Direction (5.0)	NA	NA	NA	NA	NA	NA	NA	NA	NA	NA

#### LEGEND

<b>X</b>	Not permitted
<b>P</b>	Permitted, application needed
<b>PE</b>	Permitted, exempt from application
<b>S</b>	Permitted, total site signage plan required
<b>NA</b>	Not applicable

Note: It should be noted that certain particular types of signs are not permitted (X) in any zones. The Policy details every type of advertising sign so as to avoid confusion which would occur if certain types were not described. Council presently considers those listed as not permitted are not acceptable forms of signage for that zone.

### 3.0 STANDARDS FOR ALL SIGNS

3.1 The following standards apply to all advertising signs and devices.

3.1.1 All advertisement signs and devices shall:

- not pose a threat to public safety or health;
- not extend beyond any boundary of a lot except with the approval of the Council.

3.1.2 If illuminated the advertising sign or device shall:

- not cause a nuisance, by way of light spillage, to abutting sites or roadways;
- not comprise flashing, running or intermittent lights;
- not interfere with or be likely to be confused with traffic control signals or create a traffic hazard;
- have any boxing or casing in which it is enclosed constructed of incombustible material;
- where comprising glass (other than fluorescent tubing) have the glass so protected as to prevent its falling into a public place in the event of breakage;
- have its electrical installation constructed and maintained to the satisfaction of Western Power or the appropriate electrical supply authority and in accordance with the relevant Australian Standard.

3.2 The Council may vary a standard or provision subject to conditions it thinks fit. However, all applications for variations must include justification for the variation and in most cases that will involve the submission of a Total Site Signage Plan.

3.3 The surface area of a sign is calculated in square metres – that is, its measured height x breadth.

When assessing odd or unusual shaped signs ( for example, spheres, columns, animal shapes, etc.) the Council will define the surface area of the sign as its area in silhouette or profile when viewed from any one perspective. That is, the sign's maximum assessable surface area will equate to its maximum silhouette or profile.

3.4 Every sign shall be securely fixed to the structure by which it is supported to the satisfaction of Council and shall be maintained in a safe condition.

3.5 All signs shall be designed, constructed, finished, installed and maintained to a standard compatible with their surroundings including buildings, landscaping and other signs.

3.6 Signs attached to buildings shall reflect the architectural features of the building in placement, style and proportions.

- 3.7 A person shall not erect a sign so as to obstruct access to or from a door, fire escape or window, other than a window designed for the display of goods.

## 4.0 TOTAL SITE SIGNAGE PLAN

- 4.1 A Total Site Signage Plan (TSSP) means an overall plan of the whole of the subject site showing the location and size of all advertisement signs proposed for the site, as well as the outline of any buildings, car parking areas, vehicular access points to the site, etc. Any existing signs must also be included on the plan and clearly delineated.
- 4.2 A request by an applicant to vary a standard with this Policy may require a TSSP to be developed and submitted by the applicant as part of the request for the variation.
- 4.3 The Council requires a TSSP to be drawn up by an applicant to enable it to assess any request for the variation of standards in the context of the total site. While a requested variation may appear to an applicant to be of a minor nature. The Council has a responsibility to the wider community, and must assess all aspects of the proposed sign’s impact in terms of all the issues set down in this Policy.
- 4.4 A TSSP is only required as part of an application when some variation from the standards is requested or a development is proposed that has potential for many signs.
- 4.5 All subsequent applications for an advertisement sign on the subject lot must be in accordance with the approved TSSP. If not a new TSSP may be required to be approved by the Council.

### A “Simple Total Site Signage Plan” Example

A simple TSSP is suitable for the following applications only:

*Residential Zone Wall Signs*

*On Ground Signs*

*Window Signs*

*Product Display Signs*

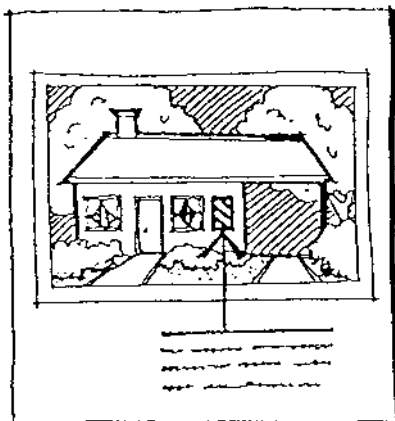

1. A clear illustration of where the sign/s will be placed on the site or building. This could be:
  - a drawing of the sign done to the correct scale and pasted to a photograph;
  - a sketch on your builder’s plans and/or elevations or;
  - a perspective drawing.
 The illustration must also show the relation of the sign to neighbouring properties, so that Council can check it will not have a negative impact on your neighbours.



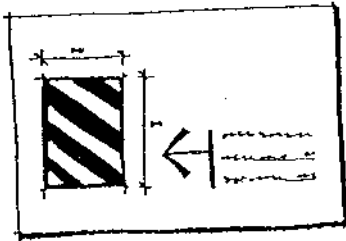

- An illustration or photograph of the sign/s with dimensions marked. (The actual content of the sign need not be shown.)



- Additional notes to support your application and outline the reasons why you may wish to vary from the standards.

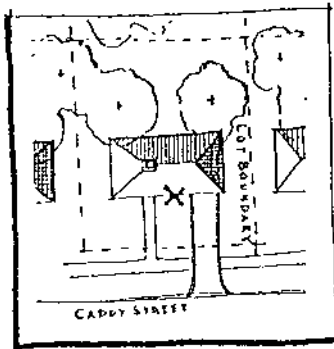

- A Site Plan showing clearly where each sign is to be located in relation to the building, site boundaries and neighbouring properties.

### A “ Complex Total Site Signage Plan” Example

A complex TSSP is to be lodged with the following signage applications.

- Above Roof*
- Part of Roof*
- Hoarding and*
- Tethered Signs*
- Wall, Projecting and Window Signs in;*
- Commercial, Professional Office and Residential Zones
- Pylons Signs in;*
- Commercial, Professional Office and Industry Zones
- Panel Signs in;*
- Commercial, Professional Office and Industry Zones

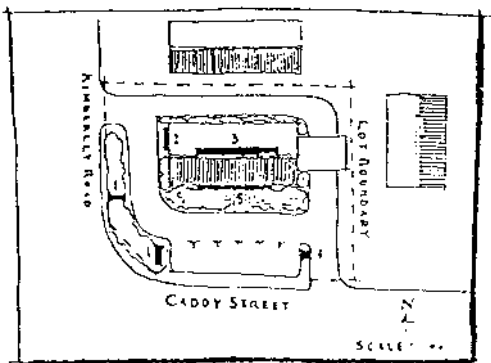

- A Site Plan showing clearly where each sign is to be located in relation to the building, site boundaries and neighbouring properties.

The plan must show;

- A scale and North point
- Lot boundaries
- Street and Road names
- Existing signs to be removed or retained.

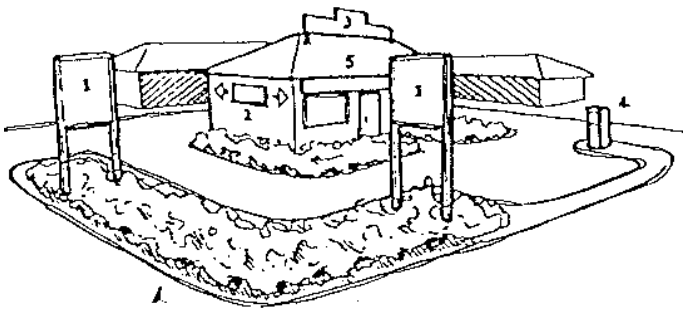

2. A perspective drawing or photomontage showing;
- Neighbouring buildings or sites
  - Lot boundaries
  - Existing signs to be removed or retained.

3. A sheet illustrating each sign to be installed and clearly showing;
- Dimensions
  - Surface areas
  - Heights above ground.

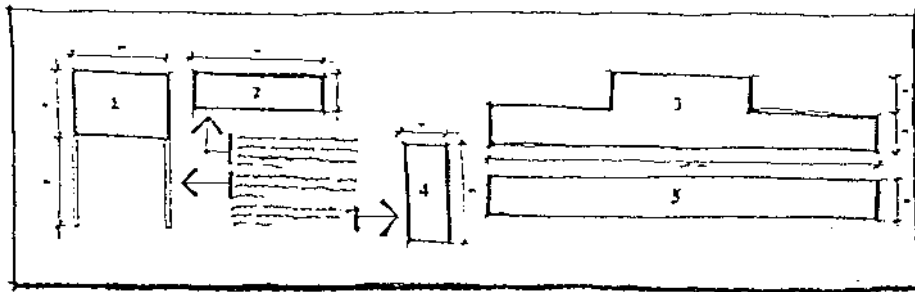

4. Additional notes to support your application.

## 5.0 BUSINESS DIRECTION SIGNS

- 5.1 This form of sign means a sign erected in a street or public place to indicate the direction to another place in the Shire but does not include any such sign erected or affixed by the Council or the Commissioner of Main Roads or a road directing sign erected or affixed by a duly incorporated association or union of motorists such as the RAC authorized in that regard by the Minister for the time being administering the Road Traffic Act 1974.
- 5.2 Council will allow erection of a direction sign which indicates the nature of the business or activity that may be located by following the direction indicated by the sign. The top of such signs shall be a maximum of 200mm wide, length of 1.5metres, with 160mm letters, white on blue background for a business or white on brown for a tourist attraction. Individual business name tags/logos may also be permitted and shall be incorporated with the sign. Such signs shall not be located more than 3.0m above the ground.
- 5.3 With the exception of the delegated area, Main Roads WA approval is required prior to the erection of signs on South Coast Highway and the Denmark/Mt Barker Road.

5.4 Where more than one such direction sign is required for a particular street junction, then they shall be incorporated into a stack sign structure which will be funded by the various businesses and erected to meet the following standards:

- each individual sign shall incorporate the business name/tag/logo/hours of opening and the direction to proceed. All letters and numbers shall be white on a blue background for businesses or white or brown for tourist attractions. The business logo may be in the business colours.
- each individual sign shall be a maximum width of 200mm and length of 1.5 metres.
- to be located to the satisfaction of the Council to ensure traffic safety.
- the overall structure shall be in the following form:

**Stack Sign**

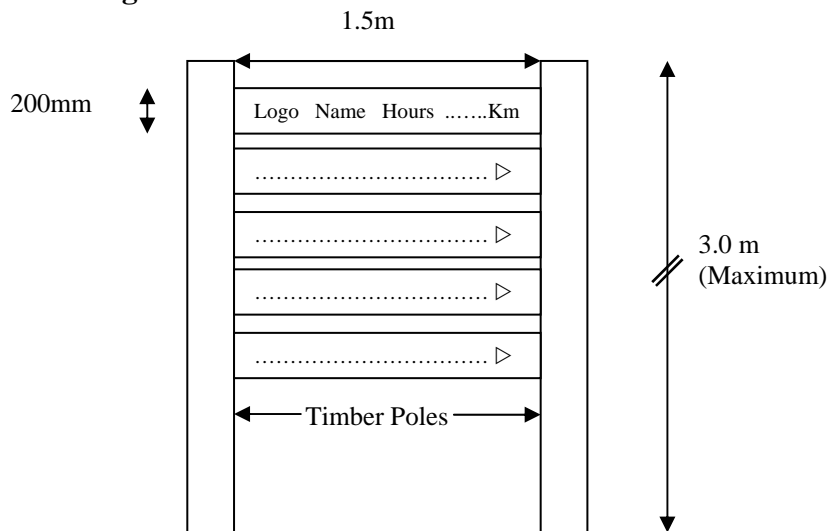

5.5 In the Central Business District this stack sign concept may not be a practical proposition from a traffic/pedestrian safety perspective. Council’s engineering staff will assess each proposed siting of appropriate sign structures. In general the above principle at 5.4 will be used but the poles will be the narrower steel form.

5.6 Where the stack sign is proposed in the rural districts and Council feels it appropriate from a traffic safety perspective, a warning direction sign shall be located in advance of the street junction. Such a warning sign shall again be a composite form as follows:

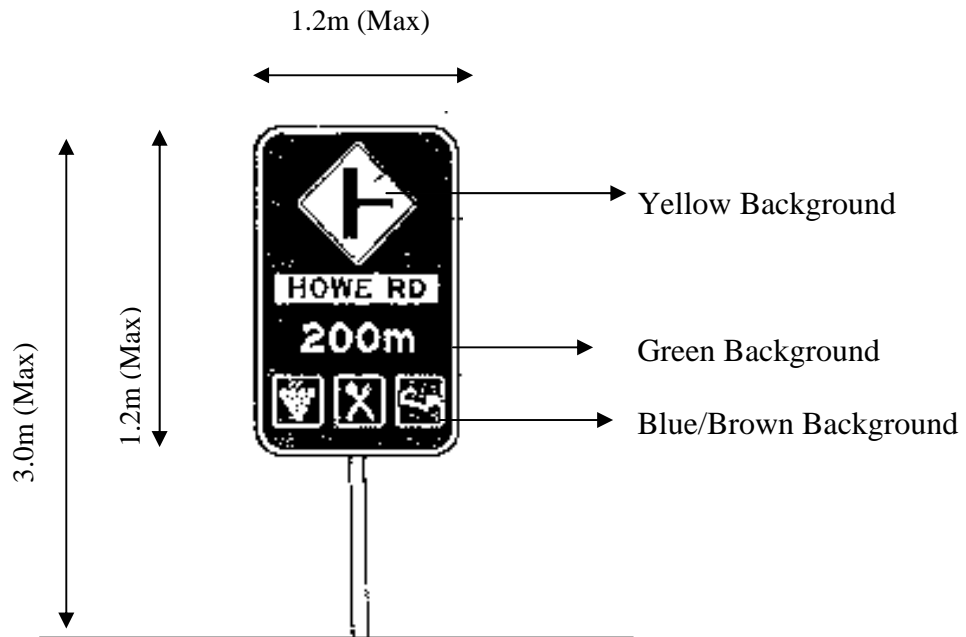

Council will have the sign prepared and erected and the cost of such sign shall be borne by the various businesses involved. Subsequent additions of symbols to the sign for new businesses will be at the cost of the new business for the necessary overlay panels.

- 5.7** A Business Direction sign is not permitted for home occupation or home holiday accommodation uses.

## 6.0 RURAL BUSINESS SIGNS ON THE ACTUAL PROPERTY

6.1 A rural business sign means a sign erected on the property where the actual business is being carried out.

6.2 A rural business sign shall –

- not indicate or display any matter other than for the purpose of advertising the sale of produce grown or made available on the land on which the sign is erected;
- be erected within the boundaries on the land on which the produce offered for sale was grown or made or alternatively on the adjoining road verge if in the opinion of Council, existing vegetation would otherwise obscure the sign;
- not exceed 2.0 square metres in area;
- not to exceed an overall height of more than 3 metres from the natural ground level;
- be secured on a frame mounted to timber or steel poles or similar, anchored securely to the ground;
- be neatly prepared and of a professional standard; and
- be kept clean and free from unsightly matter and in good condition and presentation.

- 6.3 Only one such sign will be permitted per lot, however in special circumstances such as the size of the lot or traffic safety, Council may allow two such signs to be erected.
- 6.4 Where such a sign is to be erected on a lot where more than one activity is carried out, Council will require advertising to be incorporated into one sign complying with the following –
- initial approval is to be given to the sign framework together with one or more sign infill;
  - an application is to be submitted and approval given for each subsequent infill;
  - all infills are to be of an equal size; and
  - not exceed 2.0 square metres in area and 3 metres in height from the natural ground level.
- 6.5 Colours should not conflict with traffic management signs.
- 6.6 Rural Business signs are permissible in the Rural Zone.

## **7.0 REAL ESTATE DIRECTIONAL SIGNS**

- 7.1 Real estate directional signs are those which direct persons towards a particular property that is being offered for sale. They are not located on the property but are located in a prominent position in most instances on a major arterial road with some form of indication of how to get to the property or how far away it is located. For the purposes of this policy, major arterial roads include: South Coast Highway, Denmark-Mt Barker Road, Scotsdale Road, McLeod Road, Mt Shadforth Road, Valley of the Giants Road, Peaceful Bay Road, Ocean Beach Road.
- 7.2 Council does not favour the use of these signs in an uncontrolled manner as it considers they are not in the public good in terms of the character and amenity of the district of Denmark. Council will only approve their use only in the standardised format.
- 7.3 Such directional signs will be allowed if the property for sale is in a rural area and is positioned off a major arterial road. Such signs are to be removed as soon as possible after settlement date of the property transaction or as soon as practicable up to a maximum period of 14 days after settlement.

Council's approved form of directional sign is shown below and those signs not adhering to this format will not be allowed:

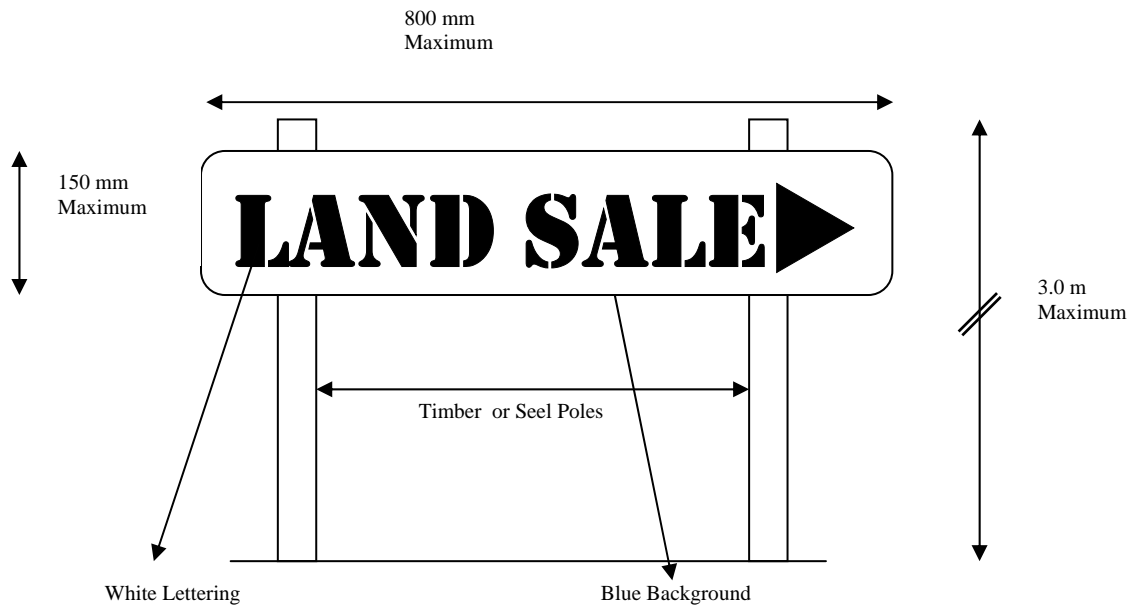

- NOTE: 1. The words on these standard signs may consist of “LAND SALE”, “AUCTION SALE” or “FARM SALE”.
2. The sign must be securely fixed to the timber or steel poles.

## 8.0 REAL ESTATE DEVELOPMENT SIGNS

- 8.1 Real estate development signs are those erected on new residential, industrial, commercial, tourist, special residential, special rural or landscape protection estates, developments or subdivisions. They are generally large and contain information such as the name of the estate, plan of the subdivision, details of facilities/number of lots/prices, leasing details, auction details etc. and the real estate agency contact details.
- 8.2 Each subdivision/development shall be permitted one such development sign except that when there are two prominent road frontages, when a second such sign shall be permitted.
- 8.3 Development signs are to be a maximum of 8 square metres in area and shall be securely mounted on timber or steel poles. The sign must be located within the land area being offered for sale.
- 8.4 Development signs are to be removed as soon as possible up to a maximum period of 14 days after settlement of the sale or the leasing of 90% of the lots.



- 8.5 Should a sold block come back on the market with another agent, during the marketing of a subdivision or development, then that agent may erect their standard “For Sale” sign.

## 9.0 REAL ESTATE “FOR SALE” SIGNS

- 9.1 “For Sale” signs are those erected on various kinds of individual properties being offered for sale and include the selling real estate agency contact details and the words “For Sale”. They are to be a maximum size of 1000mm x 1000mm (1.0m<sup>2</sup>) and erected on steel poles.
- 9.2 “For Sale” signs in the urban areas shall be limited to two such signs per property. The two signs can be located in a V shape for ease of identification and for safety reasons. Such signs do not have to be placed parallel to lot boundaries.
- 9.3 In the case of an open listing, a single “For Sale” sign shall be erected with the agent’s names and contact numbers in a neat row from top to bottom. Such signs can be erected at any angle and can be painted on both sides. The “For Sale” part of the sign is to be 800mm x 250mm with a white background and red lettering. The agent’s name plates are to be 800mm x 150mm and can incorporate the agents logo, colour scheme and phone number. When the property is sold, the “sold” sticker is to go on the selling agent’s name plate. Real estate agencies will provide the generic signs with the agent getting the first open listing for a property being responsible for erecting and removing the sign and able to place their name plate first.
- 9.4 In the case of a joint exclusive between two agents, then both agents can erect one normal “For Sale” sign each. If more than two agencies are involved then the open listing format above shall be used.
- 9.5 The “For Sale” signs are to be removed as soon as possible after settlement of the property transaction or as soon as practicable up to maximum period of 14 days after settlement.
- 9.6 The “For Sale” sign described above shall also be interpreted to include those advertising properties or premises to “Lease” or to “Let”.

## 10.0 ON BUILDING SIGNS

### 10.1 Above Roof Sign

- 10.1.1 This is an advertising sign, which protrudes above the normal roof line with little or no relation to the architectural design of the building. It does not however include a “Part of Roof” sign.

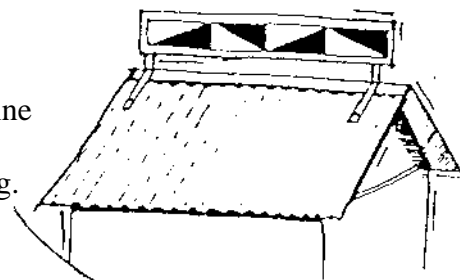

10.1.2 Notwithstanding the above an Above Roof sign is not permitted in any zone.

**10.2 Part of Roof Sign**

10.2.1 This is an advertising sign, which is fixed to a fascia, or to the roof itself or which forms part of a projection above the eaves, or ceiling of the building.

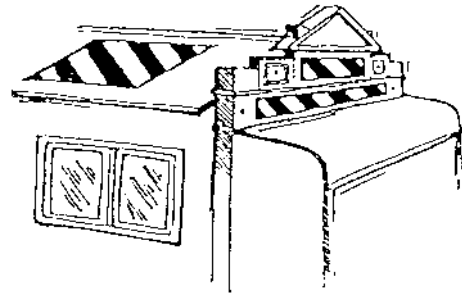

10.2.2 A Part of Roof sign shall be fixed parallel to the fascia or portion of the building (including the roof) to which it is attached.

10.2.3 A Part of Roof sign shall have a maximum area of 3m<sup>2</sup>, it shall not project more than 300mm from the portion of the building to which it is attached and shall not be within 500mm of either end of the fascia, roof or parapet of the building to which it is attached.

10.2.4 Part of Roof signs are only permitted in the Commercial, Tourist and Industrial Zones and require an application to Council accompanied by a Total Site Signage Plan.

**10.3 Wall Sign**

10.3.1 This is an advertising sign which is fixed to the external part of a wall of the building but does not project more than 300mm out from the wall, and no part of which is above the lowest point of the eaves or ceiling of the building.

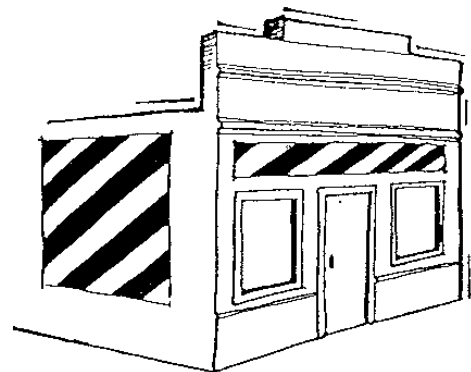

10.3.2 Wall signs shall be limited to a maximum number of two such signs on any one wall for each tenancy within a building other than a building within a Residential zone.

10.3.3 Wall signs shall not exceed 10m<sup>2</sup> in area in aggregate on any one wall or 25% of that wall area unless a Total Site Signage Plan for the whole site has been submitted and approved by Council.

10.3.4 A Wall Sign, if placed directly over door openings, shall not project below the top of that door.

10.3.5 A Wall Sign if located within a Residential zone and attached to a building used predominantly for a residential use, shall;

- not exceed 0.2m<sup>2</sup> in area; and
- not exceed one sign per lot.

10.3.6 A Wall sign if located within a Residential zone and attached to a building used predominantly for a commercial use, shall;

- not exceed 0.2m<sup>2</sup> in area; and
- not exceed one sign per lot.

10.3.7 Wall signs are permitted in the Commercial, Industrial, and Tourist Zones. In the Residential, Professional Office and Rural Zones Wall signs are only permitted once an application incorporating a Total Site Signage Plan is submitted and approved.

10.3.8 Wall signs are permitted for places of public worship, meeting and assembly halls provided only one sign is placed on each building and such signs shall not exceed 0.2m<sup>2</sup>.

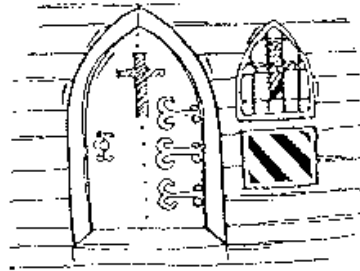

10.3.9 Wall signs to display the name, number and address of a building are permitted provided only one sign is placed on each building and such signs shall not exceed 0.2m<sup>2</sup>.

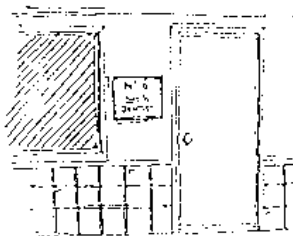

10.3.10A Wall sign is not permitted for home holiday accommodation..

## 10.4 Projecting Signs

10.4.1 This is an advertising sign which is attached to a projection (including a verandah) which projects more than 300m from a wall of the building below the eaves or ceiling height.

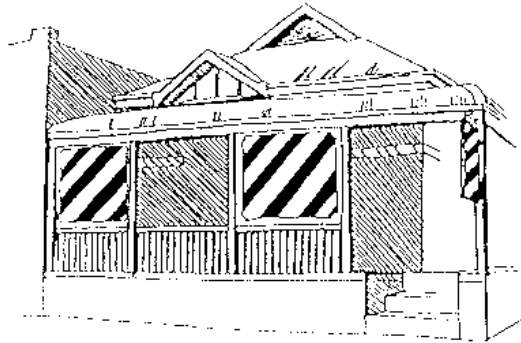
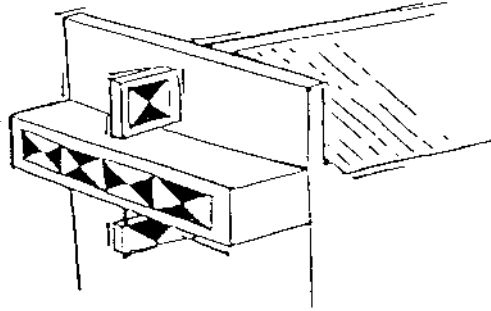

10.4.2 Projecting signs shall be limited to one such sign per tenancy on a lot other than any projecting signs that are attached to the fascia of the verandah or the like. All such signs shall have a minimum clearance of 2.4m from the ground.

10.4.3 Projecting signs on the fascia of a verandah shall not exceed 600mm in a vertical dimension and shall not project beyond the outer frame or surrounds of the fascia.

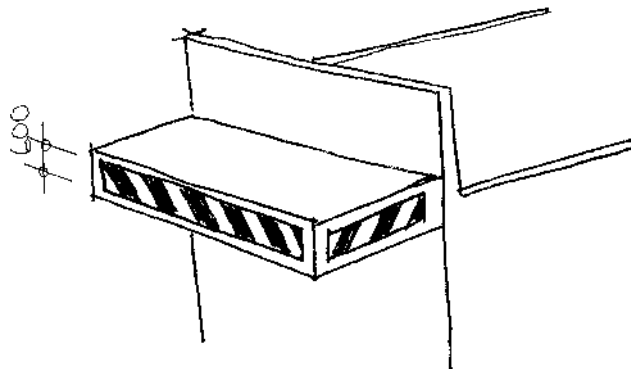

10.4.4 Projecting signs on the underside of a verandah shall not:

- exceed 2.4m in length
- exceed 600mm in a vertical dimension
- weigh more than 30kg
- be within 3.0m of another such sign attached to the underside of the same verandah unless deemed acceptable to Council, or
- project beyond the outer frame or surround of the verandah.

10.4.5 Projecting signs on the underside of a verandah shall be at right angles to the front street boundary except on a corner lot where the signs may be placed so as to be visible from both streets.

10.4.6 Projecting signs above a verandah shall not:

- exceed 2.0m in length
- exceed 600mm in a vertical dimension
- be within 3.0m of another such sign attached above the same verandah, or
- project beyond the outer frame or surround of the verandah.

10.4.7 Projecting signs attached directly to the building shall not:

- project more than 1.0m from the outer wall and not exceed 1.5m<sup>2</sup> in area
- be placed within 2.0m of either end of the wall to which they are attached (in exceptional circumstances such as a narrow shop front Council may allow a reduction), or
- project above the top of the wall to which they are attached.

10.4.8 Projecting signs include blinds or screens dropped vertically down from the fascia of a verandah, awning or canopy to provide protection from the sun, rain or wind where these blinds or screens contain forms of advertising. These projecting signs will only be permitted in the Central Business District. These blinds or screens shall be fixed rigidly into position and in special circumstances Council may approve such devices at the end of a verandah.

10.4.9 Any blind or screen shall have a minimum clearance of 2.1m from the ground and Council may average this headroom requirement where it is considered the device will not create a hazard for pedestrians or conflict with the built form.

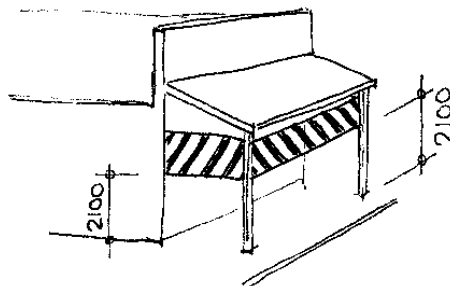

- 10.4.10 The blinds or screens are to be sympathetic to the surrounding built form in regards to design, colour and material. Preferred background colours include natural earth and vegetation colours. All blinds or screens must be kept in good repair and condition to the satisfaction of Council. Council will not permit any device to be hung below or otherwise attached to any blind. This excludes connection of the blind to a building, verandah, awning or canopy approved by Council, or the attachment of an advertising device in accordance with this policy on the face of the blind or screen.
- 10.4.11 Advertising on blinds or screens shall be limited to the name of the business or the form of activity taking place within the building (ie Chemist, Bakery etc). Signs advertising particular brand names will not be permitted. Advertisements must be either painted directly onto the blind, or alternatively securely fixed to the blind and maintained in a safe condition to the satisfaction of Council. Writing shall be limited to a single line, except where smaller print above/or below the main wording is considered incidental to the main advertisement. Maximum height of writing, is to be 300mm.

Council will only permit the illumination of blinds in special circumstances. Justifications must be presented with regard to amenity and impact on adjoining properties and passing traffic (on South Coast Highway this may require the approval of Main Roads WA).



- 10.4.12 Another technique for Projecting signs is for advertising devices to be attached to verandah posts, power poles or other features of street furniture located within road reserves. These kinds of advertising devices are not permitted. In certain cases Council may permit limited advertising in the form of lettering being painted directly onto the verandah post but it will not allow signs to be adhered to the posts in any form. The attachment of such devices to power poles and other features of street furniture such as seats or parking restriction poles is not permitted.



- 10.4.13 In the case of all Projecting signs over public land, the applicant must provide written confirmation at the time of application that they have suitable comprehensive public liability insurance to indemnify Council against any claim should an accident involving the approved Projecting sign occur.
- 10.4.14 Projecting signs are permitted in the Commercial, Industrial and Tourist Zones. In the Professional Office and Rural Zones, Projecting signs are only permitted once an application incorporating a Total Site Signage Plan is submitted and approved.
- 10.4.15 Notwithstanding the above, a Projecting sign is not permitted above a verandah (10.4.6). In the absence of a verandah fascia less than 600mm high Council may consider a projecting sign at the gutter line but not exceeding 600mm high.

## 10.5 Window Signs

- 10.5.1 This is an advertising sign, which is fixed either to the interior or exterior of the glazed area of a window and any part of which is visible from outside the building. Window signs internal to the building and which cannot be seen from outside do not require Council approval. See also 11.9.

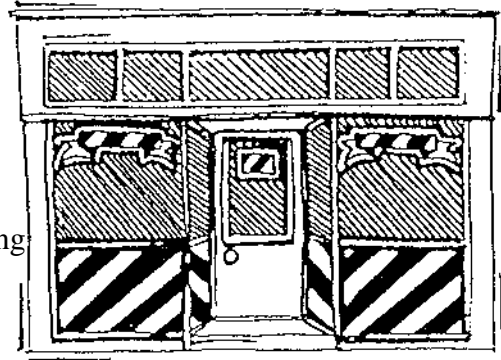

- 10.5.2 Window signs shall not cover more than 50% of the glazed area of any one window or exceed 10.0m<sup>2</sup> in area in aggregate per tenancy on a lot.
- 10.5.3 Window signs are permissible in the Commercial, Professional Office, Industrial and Tourist Zones.

## 11.0 OFF BUILDING SIGNS

### 11.1 Pylon Signs

- 11.1.1 This is an advertising sign, which is fixed to a structure which has one or more supports. The overall height (including supports) is greater than the sign's width (horizontal dimension), and portion of the sign is greater than 1.2m above natural ground level.

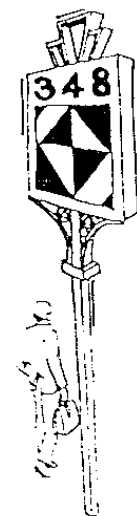

11.1.2 Pylon signs shall have a minimum clearance of 2.4m from ground level, shall not be more than 4.0m above ground level, shall not exceed 2.0m measured either vertically or horizontally across the face of the sign. Pylon signs shall not be greater than 2.0m<sup>2</sup> in area and shall be limited to one sign per street frontage on any one lot.

11.1.3 Pylon signs are only permitted in the Commercial and Industrial Zones once an application incorporating a Total Site Signage Plan is submitted and approved.

## 11.2 On Ground Signs

11.2.1 This is an advertising sign, which is not attached to a building and no portion of this type of sign can be higher than 1.2m above ground level. These include those commonly known as sandwich board signs.

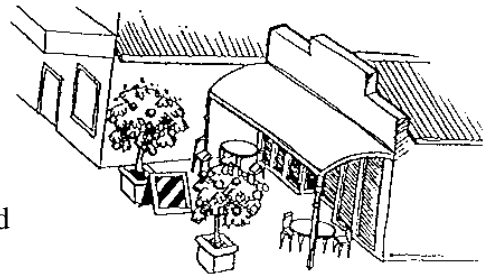

11.2.2 On Ground signs which in the opinion of Council are portable shall:

- be located wholly within the boundaries of the lot
- be displayed only during normal business hours of the business to which the sign relates
- be limited to a maximum of one sign per tenancy on a lot
- have no moving parts once the sign is in place
- where relevant display the word “open” and
- have a maximum vertical or horizontal dimension of 1.0m and have an area of not more than 0.6m<sup>2</sup>.

11.2.3 On Ground signs which in the opinion of Council are not portable shall:

- be located wholly within the boundaries of the lot
- have a maximum vertical dimension of 1.2m and a maximum area of 1.0m<sup>2</sup>
- advertise only products or services available from the lot and
- be limited to a maximum of one sign per street frontage on any one lot.

11.2.4 On Ground signs are permissible in the Commercial, Tourist and Industry Zones. On Ground signs in the Professional Office Zone are only permitted once an application incorporating a Total Site Signage Plan is submitted and approved.

11.2.5 On Ground signs are not permitted for holiday accommodation uses.

### 11.3 Panel Signs

11.3.1 This is advertising sign, which is fixed to a panel and is greater than 1.2m above ground level. It does not include a pylon sign, a hoarding sign or a real estate development sign.

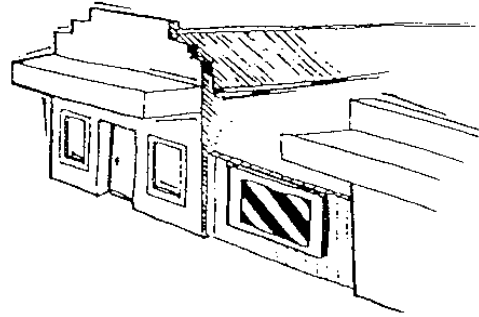

11.3.2 A Panel sign shall have a maximum vertical dimension of 1.5m and a maximum area of 4.0m<sup>2</sup>.

11.3.3 A Panel sign shall not:

- in aggregate have a combined area of 16m<sup>2</sup> per lot
- not be less than 1.0m or greater than 2.5m from ground level
- not be erected in the area between building and the front boundary of a lot except with the approval of Council, and
- not be with 10m of another panel sign on the same lot.

11.3.4 Panel signs are permissible in the Commercial and Industrial Zones only and require an application incorporating a Total Site Signage Plan.

### 11.4 Hoarding Sign

11.4.1 This is an advertising sign, which is fixed to a structure and which has one or more supports. The overall height (including supports) is less than the sign's width (horizontal dimension). Part of the sign must be greater than 1.2m above ground level.

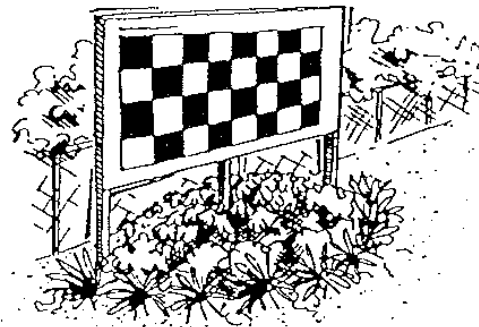

11.4.2 A Hoarding sign shall have a maximum area of 10m<sup>2</sup> and be limited to a maximum of one such sign per street frontage of the lot.

11.4.3 A Hoarding sign shall not:

- be less than 1.2m or greater than 2.5m from ground level and
- be erected in the area between any building and the front boundary of a lot.

11.4.4 Notwithstanding the above a Hoarding sign is not permitted in any zone.

## 11.5 Tethered Signs

11.5.1 This is an advertising sign, which is suspended from or tethered (tied) to any structure or tree or pole (with or without supporting framework). The sign may be made of paper, plastic, fabric or a similar material. It includes “lighter than air” aerial devices, inflatables, bunting, banners, flags, semaphore signs and kites.

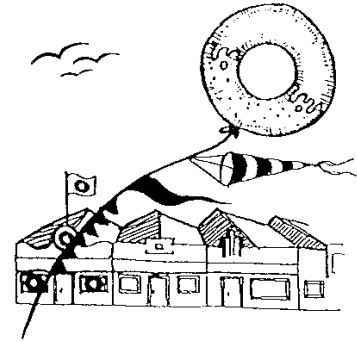

11.5.2 A Tethered sign shall be located wholly within the boundaries of the lot and have a maximum vertical dimension of 0.75m and a maximum area of 2m<sup>2</sup>.

11.5.3 A Tethered sign shall be limited to a maximum of one sign per street frontage or any one lot.

11.5.4 A Tethered sign shall not:

- be less than 2.5m or greater than 5.0m from ground level, and
- be within 10m of a Pylon sign.

11.5.5 A Tethered sign which consists of balloon type objects shall not:

- exceed 5.0m in diameter or 6.0m in height, and
- be displayed for more than 14 days in aggregate in any one calendar year.

11.5.6 Notwithstanding the above a Tethered sign is not permitted in any zone.

## 11.6 Product Display Sign

11.6.1 This is an advertising sign applied to, or adhered to or placed on a vehicle (the vehicle might be a car, truck, boat, trailer, caravan, machinery or similar whether moveable or not). It can be a product or object, which is displayed for the purpose of advertising.

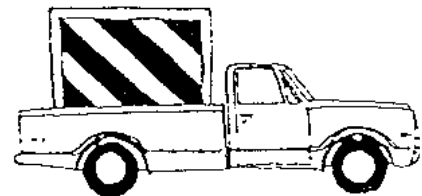

11.6.2 A Product Display sign shall be located wholly within the boundaries of the lot, placed so as to not cause any interference, whether directly or indirectly, to vehicular traffic or pedestrians, have no moving parts, limited to a maximum of one sign per street frontage on any one lot and have a maximum vertical or horizontal dimension of 2.0m.

11.6.3 A Product Display sign shall not be located within road or any other public reserves.

11.6.4 A Product Display sign does not include sign writing painted onto vehicles.

11.6.5 A Product Display sign is permissible in the Industrial and Rural Zones.

## 11.7 Construction Site Signs

11.7.1 This is an advertising sign, which is displayed only for the duration of the construction of a building or development. It does not include a Real Estate Development sign. This sign can also include a tradesman's individual trades' signs or logos.

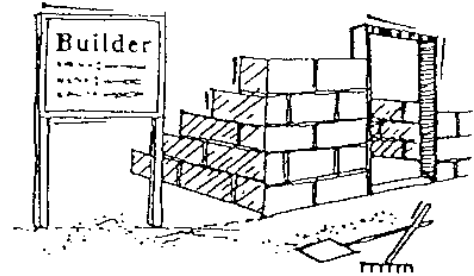

11.7.2 A Construction Site sign shall be limited to one sign per street frontage and contain details of the project and the contractors undertaking the construction work.

11.7.3 A Construction Site sign shall be limited to 2.0m<sup>2</sup> for housing, commercial, professional office and industrial developments.

11.7.4 Construction Site signs are permitted in all zones.

## 11.8 Display Home Signs

11.8.1 This is advertising sign displayed for the period over which homes are on display for public inspection.

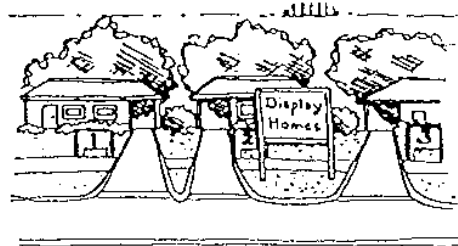

11.8.2 One Display Home sign is permitted for each dwelling on display. The sign can have a maximum area of 2.0m<sup>2</sup>.

11.8.3 Display Home signs cannot be illuminated.

11.8.4 Display Home signs are permitted in all Residential and Special Residential zones.

## 11.9 Signs for Public Information

11.9.1 Notwithstanding any other provision of this Policy the Council may allow the display of advertisements of meetings, charitable functions, art or cultural activities or other events of public interest or the display of advertisements at theatres and other places of public entertainment (other than those conducted by a person for the purpose of commercial gain unless in the interest of the community or tourists).

- 11.9.2 A person shall not erect or maintain a sign more than 2 weeks before the meeting, function event or activity to which it relates and the person by whom it was erected shall cause it to be removed not later than 24 hours after the conclusion of the meeting, function, event or activity.
- 11.9.3 Upon the expiry of an approval or the issue of an enforcement notice for this type of temporary sign the person to whom it was issued shall forthwith remove the advertisement to which it relates.
- 11.9.4 In respect to the activity commonly referred to as a “Garage Sale” sign(s) can be placed within road reserves directing people to the property the sale is being conducted at, but the sign(s) can only be placed on display on the day of the garage sale. The maximum size permissible for this type of sign is 0.4m<sup>2</sup>. Such signs must be neatly prepared and be located in positions so as to not cause a traffic or pedestrian hazard. Such signs must be removed immediately upon the completion of the sale on the day.

## 12.0 EXISTING SIGNS

- 12.1 Existing signs are those which were erected, placed or displayed lawfully prior to the coming into force of this Policy.
- 12.2 No provision of this Policy shall prevent the continued use of a sign for which, immediately prior to this Policy coming into operation, all licences and approvals required to authorise the erection of the sign, were duly obtained and are current.
- 12.3 However, where Council considers that a particular sign conflicts with the aims or objectives of this Policy it may serve an enforcement notice to require the advertiser to remove or adapt the sign.

## 13.0 PROHIBITED SIGNS

- 13.1 The following are expressly prohibited by this Policy –
- A Flag other than an Australian National Flag, WA State Flag, and a flag or banner for a specific event, function/celebration, unless approved by Council
  - Bunting or other form of tethered sign including semaphore signs
  - Flashing, intermittent or sequential lights
  - A sign on a roof of a building or on the roof of a verandah
  - Sandwich-board signs, except on private property
  - A sign which rotates or tumbles
  - A hoarding
  - An electoral sign, except on private property
  - A sign advertising facilities, goods or services not on the actual property
  - A bill or flyposter except on the interior face of shop windows (10.5)



- A sign nailed or otherwise affixing to a tree; and
- Any sign which in the opinion of Council is contrary to the aims and objectives of the Policy as detailed earlier in this document.

## **14.0 ENFORCEMENT**

- 14.1 The Council has powers to enforce compliance with the approvals and conditions it issues for advertising signs.
- 14.2 The Council may serve an enforcement notice upon a non-complying advertiser, and the notice shall specify the following:
- the advertisement sign(s) in question;
  - full details of the action to be taken by the advertiser to comply with the notice;
  - the period (which will not be less than 28 days ) within which the action specified by the Council shall be completed by the advertiser.
- 14.3 The signs addressed by this Policy and the above prohibited signs which do not have Council approval shall be removed within 28 days of the owner of the sign (the advertiser) being advised by an enforcement notice to do so by Council.
- 14.4 Any person upon whom an enforcement notice is served may, within a period of 60 days from the date of the notice, appeal against the Council's action – either to the Minister for Planning or to the Town Planning Appeal Tribunal. Where any such appeal is lodged, the effect of the notice shall be suspended until the appeal is determined.
- 14.5 Any person who fails to comply with the requirements of an enforcement notice commits an offence as set out in Town Planning Scheme No 3 and is liable to the penalties prescribed in section 10 of the Town Planning & Development Act 1928 (as amended).
- 14.6 If a person fails to comply with the requirements of the enforcement notice, representatives of the Council may enter the subject land and carry out the requirements of the notice and Council may then recover its costs as a debt from the person who failed to comply with the enforcement notice.

## **15.0 PLANNING CONSENT**

- 15.1 The types of signs detailed at 9.0, 10.3.5, 10.3.6, 10.3.8, 10.3.9, 10.5.1 (in part), 11.7 and 11.8 inclusive will not require an application for Planning Consent to be lodged as they are exempted advertisements under clause 5.30 of the Town Planning Scheme No. 3 provided they meet the Policy requirements.

- 15.2 Where considered warranted, an application for Planning Consent shall be accompanied by a completed Appendix 9 – Control of Advertisements additional information sheet as contained in Town Planning Scheme No. 3 and attached to this policy.
- 15.3 Where a sign, which requires an application for Planning Consent conforms with the requirements listed in this Policy then a Notice of Approval of Planning Consent will be issued. Where such a sign is proposed to depart from the requirements listed, then the application will be considered in the context of the aims and objectives of this Policy.
- 15.4 In respect to Signs for Public Information (11.9), an application for Planning Consent is not required. Approval of the Chief Executive Officer is required to be obtained for these types of temporary signs.

## **16.0 FEES**

Council may charge a fee in respect to applications for planning consent for signs.

*This Policy No 32 supersedes TPS Policy No's 27.1 (Specific Signs), 30 (Signs on Blinds within the Denmark Central Business District) and the signage components of Policy No. 26 (South Coast Highway Commercial Developments).*

Adopted on 22<sup>nd</sup> May, 2001 in accordance with clause 8.2 of Town Planning Scheme No. 3.

TOWN PLANNING SCHEME NO. 3  
“APPENDIX 9 - CONTROL OF ADVERTISEMENTS”

**ADDITIONAL INFORMATION SHEET FOR ADVERTISEMENTS APPROVAL**  
(to be completed in addition to Application for Approval to Commence Development)

Name of Advertiser (if different from owner):

.....

Address in full:

.....

Description of Property upon which advertisement is to be displayed including full details of its proposed position within that property:

.....

.....

Details of Proposed Sign:

Height: ..... Width: ..... Depth: .....

Colours to be used: .....

Height above ground level (to top of advertisement): .....

(to underside): .....

Materials to be used: ..... Illuminated: Yes/No

If yes, state whether steady, moving, flashing, alternating, digital, animated or scintillating etc:

.....

If yes, state intensity of light source: .....

State period of time for which advertisement is required: .....

Details of signs, if any to be removed if this application is approved: .....

.....

.....

**NB.** Application should be supported by a photograph or photographs of the premises showing superimposed thereon the proposed position for the advertisement and those advertisements to be removed detailed above.

Signature of Advertiser(s): ..... DATE: .....  
(if different from landowners)

---

**EXTRACT FROM T.P.S. NO. 3 – CLAUSE 5.30 – CONTROL OF ADVERTISEMENTS****5.30 CONTROL OF ADVERTISEMENTS**

5.30.1 Council's objectives in the control of advertising signs is:

to secure the orderly and proper planning and the amenity of the Scheme Area through the control of advertisements by the examination and determination of applications for advertising signs in the light of:

- the impact of new advertisements upon residential, rural and recreational areas;
- the potential of any proposed advertisement to enhance or detract from the visual amenity and character of an area; and
- the potential for the rationalisation, consolidation or removal of existing advertisements where amenity is already impaired by poor, excessive or derelict advertising.

5.30.2 Power to Control Advertisements

5.30.2.1 For the purpose of this Scheme, the erection, placement and display, and, subject to the provisions of Clause 5.30.6, the continuance of advertisements is development within the definition of the Act requiring, except as otherwise provided, the prior approval of the Council. Such a planning consent is required in addition to any licence pursuant to Council's Signs, Billposting and Hoardings Bylaws.

5.30.2.2 Applications for Council's consent pursuant to this Part shall be submitted in accordance with the provisions of Part 6 of the Scheme and shall be accompanied by a completed Additional Information Sheet in the form set out at Appendix 9 giving details of the advertisement(s) to be erected, placed or displayed on the land.

5.30.3 Existing Advertisements

Advertisements which:

- (i) were lawfully erected, placed or displayed prior to the approval of this Scheme; or
- (ii) may be erected, placed or displayed pursuant to a licence or other approval granted by the Council prior to the approval of this Scheme hereinafter in this Part referred to as 'existing advertisements';

may, except as otherwise provided, continue to be displayed or be erected and displayed in accordance with the licence or approval as appropriate.

#### 5.30.4 Consideration of Applications

Without limiting the generality of the matters which may be taken into account when making a decision upon an application for consent to erect, place or display an advertisement, Council shall examine each such application in the light of the objectives of the Scheme and with particular reference to the character and amenity of the locality within which it is to be displayed.

#### 5.30.5 Exemptions from the Requirement to Obtain Consent

Subject to the provisions of the Main Roads (Control of Signs) Regulations 1983 and notwithstanding the provisions of Clause 5.30.2.1 the Council's prior consent is not required in respect of those advertisements listed in Appendix 10 which for the purpose of this Part are referred to as 'exempted' advertisements.

#### 5.30.6 Discontinuance

Notwithstanding the Scheme objectives and Clause 5.30.5 where in the opinion of the Council, an exempted or existing advertisement so seriously conflicts with the objectives of this Part, it may by notice in writing require the advertiser to remove, relocate, adapt, or otherwise modify the advertisement.

#### 5.30.7 Derelict or Poorly Maintained Signs

Where, in the opinion of the Council, an advertisement has been permitted to deteriorate to a point where it conflicts with the objectives of the Scheme or it ceases to be effective for the purpose for which it was erected or displayed, Council may by notice in writing require the advertiser to:

- (i) repair, repaint or otherwise restore the advertisement to a standard specified by Council in the notice; or
- (ii) remove the advertisement.

#### 5.30.8 Notices

5.30.8.1 'The advertiser' shall be interpreted as any one or any group comprised of the owner, occupier, licensee or other person having interest in or drawing benefit from the display of the advertisement concerned.

5.30.8.2 Any notice served pursuant to Clauses 5.30.6 and 5.30.7 shall be served upon the advertiser and shall specify:

- (i) the advertisement(s) the subject of the notice;
- (ii) full details of the action or alternative courses of action to be taken by the advertiser to comply with the notice;
- (iii) the period, not being less than 28 days, within which the action specified shall be completed by the advertiser.

5.30.8.3 Any person upon whom a notice is served pursuant to this Part may within a specified period of 28 days from the date of the notice appeal to the Hon Minister for Planning or the Town Planning Appeal Tribunal in accordance with Part V of the Act, and where any such appeal is lodged the effect of the notice shall be suspended until the decision to uphold, quash or vary the notice is known and shall thereafter have effect according to that decision.

#### 5.30.9 Scheme to Prevail

Where the provisions of this Part are found to be at variance with the provisions of the Council's Signs, Billposting and Hoardings Bylaws, the provisions of the Scheme shall prevail.

#### 5.30.10 Enforcement Penalties

Any advertiser who:

- (i) erects, places or displays or who permits to be erected, placed or displayed an advertisement otherwise than in accordance with the provisions of this Part; or
- (ii) fails to comply with any notice issued pursuant to this Part; commits an offence and is liable to the remedies available to the Council pursuant to Section 10 of the Act.



**APPENDIX 10(a) - EXEMPTED ADVERTISEMENTS PURSUANT TO CLAUSE 5.30.5**

<b>LAND USE AND/OR DEVELOPMENT REQUIRING ADVERTISEMENT</b>	<b>EXEMPTED SIGN TYPE AND NUMBER</b> (includes the change of posters on poster signs and applies to non-illuminated signs unless otherwise stated)	<b>MAXIMUM AREA OF EXEMPT SIGN</b>
Dwellings	One Professional name-plate as appropriate.	0.2m <sup>2</sup>
Home Occupation	One advertisement describing the nature of the home occupation.	0.2m <sup>2</sup>
Places of Worship, Meeting Halls and Places of Public Assembly	One advertisement detailing the function and/or the activities of the institution concerned.	0.2m <sup>2</sup>
Cinemas, Theatres and Drive-in Theatres	Two signs (illuminated) detailing the entertainment being presented from time to time at the venue upon which the signs are displayed.	Each advertisement sign not to exceed 5m <sup>2</sup>
Shops, Showrooms and other uses appropriate to a Shopping Area	All advertisements affixed to the building below the top of the awning or, in the absence of an awning, below a line measured at 5 metres from the ground floor level of the building subject to a compliance with the requirements of the Signs Hoarding and Bill Posting Bylaws.	Not applicable
Industrial and Warehouse Premises	A maximum of 4 advertisements applied to or affixed to the walls of the building but not including signs which project above the eaves or the ridge of the roof of the building whether or not those signs are connected to a pole, wall or other building.  A maximum of two free-standing advertisement signs not exceeding 5m in height above ground level.	Total area of any such advertisements shall not exceed 15m <sup>2</sup> .  Maximum permissible total area shall not exceed 10m <sup>2</sup> and individual advertisement signs shall not exceed 6m <sup>2</sup>
Showrooms, Race Courses, Major Racing Tracks, Sports Stadia, Major Sporting Grounds and Complexes	All signs provided that, in each case, the advertisement is not visible from outside the complex or facility concerned either from other private land or from public places and streets.	Not applicable
Public Places and Reserves	(a) Advertisement signs (illuminated and non-illuminated) relating to the functions of government, a public authority or council of a municipality excluding those of a promotional nature constructed or exhibited by, or on behalf of any such body; and	Not applicable

LAND USE AND/OR DEVELOPMENT REQUIRING ADVERTISEMENT	EXEMPTED SIGN TYPE AND NUMBER (includes the change of posters on poster signs and applies to non-illuminated signs unless otherwise stated)	MAXIMUM AREA OF EXEMPT SIGN
	<p>(b) Advertisement signs (illuminated and non-illuminated) required for the management or control of traffic on any public road, car park, cycleway, railway or waterway where such advertisement has been constructed or exhibited by or at the direction of a Government department, public authority or the council of a municipality; and</p> <p>(c) Advertisement signs (illuminated and non-illuminated) required to be exhibited by or pursuant to any statute or regulation or the like made pursuant to powers contained within a statute provided that any such advertisement is constructed and/or exhibited strictly in accordance with the requirements specified therein.</p>	<p>Not applicable</p> <p>Not applicable</p>
Railway Property and Reserves	Advertisement signs exhibited on such land provided that each such advertisement is directed only at or upon a railway station.	No sign shall exceed 2m <sup>2</sup> in area
Advertisements within buildings	All advertisements placed or displayed within buildings which cannot ordinarily be seen by a person outside of those buildings.	Not applicable
All classes of buildings other than single family dwellings	One advertisement sign containing the name, number and address of the building, the purpose for which the building is used or the name and address of the managing agent thereof.	0.2m <sup>2</sup>

**APPENDIX 10(b) EXEMPTED ADVERTISEMENTS**

<b>TEMPORARY SIGNS</b>	<b>EXEMPTED SIGN TYPE AND NUMBER</b> (all non-illuminated unless otherwise stated)	<b>MAXIMUM AREA OF EXEMPT SIGN</b>
<p>Building Construction Sites (advertisement signs displayed only for the duration of the construction) as follows:</p> <p>(i) Dwellings</p> <p>(ii) Multiple Dwellings, shops, Commercial and Industrial Projects</p> <p>(iii) Large Development or redevelopment projects involving Shopping Centres, Office or other buildings exceeding 3 storeys in height</p>	<p>One advertisement per street frontage containing details of the project and the contractors undertaking the construction work.</p> <p>One sign as for (i) above.</p> <p>One additional sign showing the name of the project builder.</p>	<p>2m<sup>2</sup></p> <p>5m<sup>2</sup></p> <p>5m<sup>2</sup></p>
<p>Sales of Goods or Livestock</p>	<p>One sign per lot displayed for a period not exceeding 3 months advertising the sale of goods or livestock upon any land or within any building upon which the sign is exhibited provided that the land is not normally used for that purpose.</p>	<p>2m<sup>2</sup></p>
<p>Property Transactions</p> <p>Advertisement signs displayed for the duration of the period over which property transactions are offered and negotiated as follows:</p>		

<p>(a) Dwellings</p> <p>(b) Multiple Dwellings, Shops, Commercial and Industrial Properties</p> <p>(c) Large properties com-prise of Shopping Centres, buildings in excess of four storeys and rural properties in excess of 5ha</p>	<p>One sign per street frontage for each property relating to the sale, leasing or impending auction of the property at or upon which the sign is or the signs are displayed.</p> <p>One sign as for (a) above.</p> <p>One sign as for (a) above.</p>	<p>Each sign shall not exceed an area of 2m<sup>2</sup>.</p> <p>Each sign shall not exceed an area of 5m<sup>2</sup>.</p> <p>Each sign shall not exceed an area of 10m<sup>2</sup>.</p>
<p>Display Homes</p> <p>Advertisement signs displayed for the period over which homes are on display for public inspection.</p>	<p>(i) One sign for each dwelling on display.</p> <p>(ii) In addition to (i) above, one sign for each group of dwellings displayed by a single project builder giving details of the project building company and details of the range of dwellings on display.</p>	<p>2m<sup>2</sup></p> <p>5m<sup>2</sup></p>